



User Manual

OPERATING, SAFETY AND MAINTENANCE INSTRUCTIONS

Issue 2.1e

SIGNALING



LISTED

Fire Alarm Equipment
77TL
Smoke Aerosol
Generator



Read and understand this manual before using Trutest.
Failure to do so will increase the risk of injury.

i. SAFETY INSTRUCTIONS

Before operating Trutest, read this User Manual and become familiar with it and the equipment. Safe and efficient operation can be achieved only if the equipment is properly operated and maintained. Accidents are caused by failure to follow fundamental rules and precautions.

This product has been designed and tested to ensure good service and safe operation and the instructions in this manual will permit the user to get the most from Trutest. It has been safety tested and listed for generic use with fire detectors by Underwriters Laboratories in Northbrook, Illinois, USA.

The following symbols, found in this manual, alert you to potentially dangerous conditions to the operator, bystanders, property, or the equipment:



This symbol refers to a hazard or unsafe practice that can result in severe personal injury or death.



This symbol refers to a hazard or unsafe practice that can result in personal injury or product or

 **WARNING**

WORKING WITH TOOLS AT HEIGHT CAN BE DANGEROUS. Falling objects can cause serious injury or death.

Trutest is designed to be used at height. It may be mounted **solely** on the top of SOLO™ telescopic operating poles.

- The manufacturer recommends that users wear protective headgear when using Trutest above head height.
 - To ensure the safety of others, it is recommended that bystanders should be moved out of the area of use when Trutest is being used at height.
 - Do not use Trutest unless it is **securely** mounted in the correct manner on the specified operating poles. See section 3.6 of this manual for details.
 - Always ensure that the spring buttons on the operating poles and the stem at the base of Trutest's main unit are fully engaged, before raising the unit above head height. Failure to do so can result in Trutest falling from the working height.
 - Always ensure that the Trutest aerosol canister is firmly located and secured in Trutest, before raising the unit above head height. This will mean that the canister will not be displaced during operation.
 - Take great care when raising or lowering Trutest from a height. In particular, be careful not to lose control of the poles. This requires some skill, and prior practice in a safe area is recommended.
 - Beware of overhead electrical cables when using, raising or lowering Trutest from a height. High voltages can cause injury or death.
 - Ensure that Trutest is always well supported by both the user and the operating poles. This will reduce risk of user fatigue and instability when operating the unit at height.
-

 **CAUTION**

AEROSOL CANISTERS CAN BE HAZARDOUS. Pressurized containers can explode if correct method of storage and use is not observed. Contents can be ignited under certain conditions.

When using/handling/storing the Trutest aerosol:

- Always follow the instructions on the canister. Failure to do so will increase the risk of injury.
 - Read the Safety Data Sheet supplied with the product.
 - **CONTENTS UNDER PRESSURE.** Protect from direct sunlight and do not expose to temperatures exceeding 120°F (50°C). Do not pierce or burn, even after use.
 - Use in a well ventilated area. Avoid deliberate inhalation / Do not breathe spray.
 - Avoid skin and eye contact.
 - **KEEP OUT OF THE REACH OF CHILDREN.**
 - The Trutest aerosol is not defined as flammable by §1500.3 (c)(6), 16CFR, Federal Hazardous Substances Act, C.P.S.C. Regulations, USA. **HOWEVER, THE PRODUCT CAN BE IGNITED UNDER CERTAIN CIRCUMSTANCES. DO NOT SPRAY ON A NAKED FLAME OR ANY INCANDESCENT MATERIAL.**
 - Keep away from sources of ignition – No smoking.
 - 20% by mass of the contents are flammable.
-

This page is intentionally blank

ii. TABLE OF CONTENTS

i.	Safety Instructions	i
ii.	Table of Contents	v
iii.	Preface	viii
iv.	Important Notes for the User	ix
v.	Statement Of Guarantee And Liability	x
1.	TECHNICAL DESCRIPTION	1
1.1.	Why Test Sensitivity?	1
1.2.	Why Test In-Situ?	1
1.3.	Why Trutest?	1
1.4.	Trutest Principles	2
2.	INTRODUCTION TO TRUTEST	3
2.1.	Introduction	3
2.2.	Components	4
2.2.1.	Main Unit	4
2.2.2.	Control Unit	4
2.2.3.	Test Aerosols	5
3.	ASSEMBLY INSTRUCTIONS	7
3.1.	General	7
3.2.	Components of Trutest	8
3.2.1	The Control Unit	8
3.2.2.	The Main Unit	9
3.2.3.	Telescopic Operating Pole	13
3.2.4.	Extension Poles (optional)	13
3.2.5.	Battery Charger	14
3.2.6.	Interconnecting Cable	14
3.2.7.	Aerosol Canisters	14
3.2.8.	Carry / Store Case	15
3.2.9.	Pole Bag (optional)	15
3.3.	Selecting and Fitting the Diaphragm Seals	15
3.4.	Fitting the Aerosol Canister	16
3.5.	Preparatory Checks	17
3.6.	Assembling the Equipment	17

4.	OPERATING INSTRUCTIONS	21
4.1.	Preparing to Test	21
4.2.	Selecting the Detector Type	22
4.3.	Selecting the Test Mode	23
4.3.1.	Max/Min Test	23
4.3.2.	Fast Ramp Test	24
4.3.3.	Slow Ramp Test	25
4.4.	Selecting a Detector Setup for Max/Min Mode	25
4.5.	Entering New Test Parameters for Max/Min Mode	26
4.6.	Starting the Test Sequence	29
4.7.	The End of the Test	31
4.8.	Completing the Test and Clearing the Smoke	31
5.	RESULTS	33
5.1.	General Objective of Results	33
5.2.	Results Screen for Ramp Test	33
5.3.	Results Screen for Max/Min Test	34
5.4.	Warnings Shown on Result Screens	35
5.5.	Stored Results	36
5.6.	Interpretation of Results	37
5.7.	Action if a Detector Fails a Test with Trutest	38
6.	SERVICE AND MAINTENANCE	39
6.1.	User Servicing	39
6.1.1.	Cleaning	39
6.1.2.	Damage Requiring Servicing	39
6.1.3.	Replacing the Fuse	40
6.1.4.	User Calibration Check	40
6.1.5.	Membrane Condition Check	40
6.2.	Annual Servicing	41
6.3.	Service Screen	41
6.4.	Warning Messages	42
6.4.1.	Low Battery	42
6.4.2.	Service Warnings	42
6.4.3.	Empty Aerosol Can	43
6.4.4.	Sensor Drift	44
6.4.5.	Wiring Fault	44
6.4.6.	System Error	44
6.4.7.	Min/Max Error	45

6.5. Troubleshooting Guide	46
7. FREQUENTLY ASKED QUESTIONS	47
7.1. Questions on Usage	47
7.2. Questions on Sensitivity & Calibration	48
7.3. Questions on effects of Temperature & Humidity	49
7.4. Questions on Trutest Aerosol	50
7.5. Questions on Batteries and Power	51
7.6. Questions on User Input / User Interface	51
7.7. Questions on Results and Displays	52
7.8. Questions on Weight, Insulation and Practical Usage	52
8. TECHNICAL SPECIFICATIONS	55
8.1. Trutest Specifications	55
8.2. Aerosol Data	57
APPENDIX A - AUTHORIZED SERVICE CENTERS	A1
A.1 United Kingdom	A1
A.2 United States of America	A1
APPENDIX B - RESULTS PAGE	B1
APPENDIX C. - DETECTOR PERFORMANCE TABLES	C1
C.1. Method for Producing Detector Performance Tables	C1
C.2. Detector Performance Sheet	C2

iii. PREFACE

This manual is:

- 1) designed to outline the correct methods of operating and maintaining your Trutest system.
- 2) written in a logical order for first time users.
- 3) designed to be detailed. It is not, however, possible to cover all situations, possible problems or questions.
- 4) a controlled document and it is important that the User Registration card be returned.

For further information contact either:

- a) the supplier of this manual and system
- b) an authorized service center

or

- c) No Climb Products Ltd.,
Edison House,
163 Dixon's Hill Road
Welham Green,
Herts.
AL9 7JE
UK

always **quoting the serial number** of your Trutest in any communication.

iv. IMPORTANT NOTES FOR THE USER

Safety

Read this manual and the Safety Instructions before using Trutest. The user must be thoroughly acquainted with the procedures in the manual to ensure maximum safety in use.

User Registration Card

Copy the serial number onto your registration card and return in order to register the product with the manufacturer.

Power

The equipment is supplied with a universal battery charger. Remove from outlet when not in use.

Storage

Avoid places subject to direct sunlight or extremely high or low temperatures. Avoid damp or dusty places. Avoid unstable locations and high places from which the unit could fall. Always store components in carry case provided.

Spillage

Care should be taken so that objects do not fall onto, or liquids spilled into, the enclosures through the openings. Do not block the openings. Avoid exposure to rain.

Charging

Do not over-charge the NiCd Battery (charge overnight or 16 hours maximum). Charge when "Low Battery" warning is displayed. Only use the battery charger provided with this equipment. Recharge battery when new, or after prolonged periods of disuse.

Electrical Connections

Do not force any connections. All connections should be made with the power off. Only fit fuses of the recommended size and type (see Specifications, section 8).

Warranty

Service and calibration must be performed by the manufacturer or by an approved service center (see page (viii), Statement of Guarantee and Liability). Trutest has no internal user-serviceable parts. Do not remove any covers or labels. Unauthorized repair or adjustments will invalidate all warranties.

Care

Trutest is a test instrument suitable for use in the field. However, the user should exercise care, as with any item of high caliber electronic test equipment. Damage due to misuse will invalidate all warranties.

v. STATEMENT OF GUARANTEE AND LIABILITY

No Climb Products Ltd. warrants this Trutest system described herein to be free from defect in material and factory workmanship for a period of one year from the date of shipment and agrees to repair such products which, under normal usage and service, disclose the defect to be the fault of No Climb Products. No Climb Products' obligation under this warranty relates to the original purchaser and is limited to a return of the purchase price, or at the sole discretion of No Climb Products Ltd., to the repair or replacement of the system or of any of its constituent parts which may prove to be defective. For this guarantee to be valid, any material or part alleged to be defective is to be returned to No Climb Products Ltd., or an authorized service center, with prior notification and with prior approval, in writing, fully insured and transport prepaid by the purchaser, within 12 months from date of shipment from the factory.

This warranty shall not apply to any unit or to any part of parts of any unit that has or have been:

1. Subjected to misuse, abuse, negligence or accident.
2. Connected, installed, operated, adjusted or serviced other than in accordance with instructions furnished by No Climb Products Ltd.
3. Repaired, modified or otherwise worked on by any person not authorized by No Climb Products Ltd., so that in our opinion the performance or reliability of the instrument has been impaired.

Subject as above No Climb Products Ltd. reserves the right to make replacements with equivalent merchandise and to effect changes at any time in the specification, design or construction of the system without incurring obligation to make any corresponding changes in units previously delivered.

No Climb Products Ltd. accepts no liability for the repair, replacement or substitution or adjustment of any detector which has not been tested in conformity with the instructions for use of the Trutest system as detailed in this manual.

No Climb Products Ltd. assumes no liability for consequential or contingent damages for defective systems covered by this warranty, failure of delivery in whole or in part or for any other cause.

No Climb Products Ltd. assumes no liability for the consequential loss or damage to property or injury to persons resulting from the malfunctioning of fire protection systems or their components which may have been tested with this product. The safe working condition of fire systems and their ability to respond to cases of real fire is neither guaranteed nor implied by tests carried out with this product.

This warranty and the manual to which it is attached constitute the agreement of the buyer and the seller so that no terms conditions or agreements purporting to modify the terms hereof shall be binding unless previously made in writing and signed by an authorized signatory of No Climb Products Ltd.

Patents

This product is covered by U.S. and European patents. Other international patents pending.

European Patent No. (GB & FR)	0698262
German Patent No.	69404648.5
U.S.A. Patent No.	5670946

Note: Because our policy is one of continuous improvement, details of products described within this publication are subject to change without notice. All information provided within this publication is believed to be correct at the time of going to press. Every effort has been made to ensure the accuracy of information, which is provided in good faith, but nothing contained herein is intended to incorporate any representation or warranty either express or implied or to form the basis of any legal relations between the parties hereto, additional to or in lieu of such as may be applicable to a contract of sale and purchase.

1. TECHNICAL DESCRIPTION

1.1. WHY TEST SENSITIVITY?

Over-sensitive detectors are more prone to false alarms. Under-sensitive detectors tend to delay the alarm signal (if they alarm at all). The sensitivity of modern smoke detectors are well controlled during manufacture but detectors in the field are subject to airborne contaminants, aging and outside interference - factors which can all significantly affect sensitivity.

Most detectors currently installed have no facilities for monitoring their own condition. Even analogue addressable sensors can only monitor the 'clean air' response levels, and cannot allow for contamination of the mesh covering entry to the sensing chamber. In the USA, NFPA Fire Code 72, requires frequent sensitivity testing, and local codes are often more stringent.

1.2. WHY TEST IN-SITU?

In-situ testing of smoke detector sensitivity greatly reduces the time and cost of testing a detector for response sensitivity. The detector does not need to be removed for testing, and does not need to be tested once for sensitivity, and again for system response. In-situ sensitivity testing is the only way of ensuring that the undisturbed detector, as installed, is functioning correctly.

1.3. WHY TRUTEST?

A fire system is an expensive and sophisticated apparatus designed to protect life and property. It is imperative that it functions as designed. By delivering a test aerosol of known quality, type and particle size whose concentration is steadily increased, Trutest provides a quantitative assessment of sensitivity, as well as confirming that the detector is capable of receiving an external smoke stimulus and that entry to the sensing chamber is not blocked.

1.4. TRUTEST PRINCIPLES

Trutest is fully automatic. The user merely determines which type of detector is under test and which type of test he wishes to perform. This information is input via a simple menu prompt system into the control unit carried on a shoulder strap. The installed detector is covered with the transparent cup of the main unit and the keypad is pressed to begin the test.

Trutest automatically introduces to the installed detector, a test aerosol of known quality, whose concentration is controlled by the microprocessor in the control unit. The aerosol concentration is constantly increased, while being read by a stable and extremely accurate light obscuration sensor housed in the head of the main unit. A single keypad button press stops the test and the detector's response to the test aerosol is output on the digital display of the control unit. This is then compared with the minimum and maximum values specified for that detector.

For types of test that Trutest will perform, see section 4.3.

2. INTRODUCTION TO TRUTEST

2.1. INTRODUCTION

Trutest is a technologically advanced, fully field-portable device for in-situ testing of smoke detector sensitivity. The equipment is suitable for testing photoelectric and ionization detectors; conventional, addressable and analogue addressable.

 WARNING
<ul style="list-style-type: none">• Before operating Trutest, read the Safety Instructions at the start of this User Manual. Failure to do so will increase the risk of injury.

The system consists of a main unit mounted on an extendable pole, with a separate control unit and battery pack connected by an umbilical cable. The main unit comprises a cup with a membrane seal which fits around a ceiling mounted detector, and a test aerosol canister with control valve, and high accuracy smoke obscuration sensor.

The tests are conducted by raising the unit to the detector on the ceiling, and then passing a carefully controlled amount of synthetic smoke particles through the detector. The user waits for the detector to activate, and then manually stops the test and the sensitivity result is displayed by Trutest.

The control unit incorporates a microprocessor, keyboard and display, and controls the complete test sequence. A number of standard test types are available, allowing for manual control of the tests, as well as a "pass/fail" type test.

Trutest is designed to be used in the field for commissioning and periodic maintenance of all types of point smoke detectors. All the tests are designed to be employed from the ground by a service engineer, whilst the detectors are still in position, connected and working, providing an accurate simulation of a real fire.

The sensitivity test provides a *quantitative* test, providing a final value in %/ft for each detector, which indicates the actual sensitivity of the detector at that time. The readings are correlated to the UL smoke box, as described in UL268.

2.2. COMPONENTS

The complete set of equipment is comprised of the following main components (not all of which are necessarily supplied):

- Main unit
- Control unit
- Synthetic test aerosols
- Two interconnecting cables (differing lengths)
- Telescopic operating pole
- Height adjustment clamp
- Extension pole (optional)
- Two membrane seals (differing apertures)
- Battery charger
- Carry case
- User manual (this document)

The first three are described in more detail below. See section 3, Assembly Instructions, for more detailed descriptions of all components:

2.2.1. Main Unit

The main unit is mounted on a telescopic operating pole, and consists of a transparent test cup to surround the detector, a high-precision smoke sensor, various control components and internal chambers. The foot of the telescopic operating pole rests on the ground, supporting the main unit when in use.

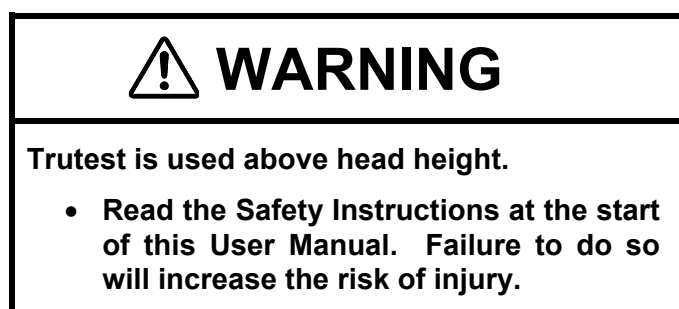

2.2.2. Control Unit

The service engineer usually carries this unit on a shoulder strap. It consists of a microprocessor, keypad and display, and the battery pack for the Trutest. The keypad and display allow the engineer to start and stop tests, change the operating parameters of the system, specify the type of detector being tested and the type of test to be performed. It also provides feedback of the test sequence and results.

2.2.3. Test Aerosols

Trutest uses a form of synthetic test smoke stored in a pressurized aerosol container. This produces a fine mist of aerosol particles to simulate the smoke from a real fire. The aerosol formula and canister are specific to Trutest, and cannot be substituted with any other test aerosol.

 **CAUTION**

Trutest uses a pressurized aerosol canister.

- **Read the Safety Instructions at the start of this User Manual. Failure to do so will increase the risk of injury.**
- **Always follow the instructions on the canister.**

This page is intentionally blank

3. ASSEMBLY INSTRUCTIONS

3.1. GENERAL

Trutest is used in the following assembly:

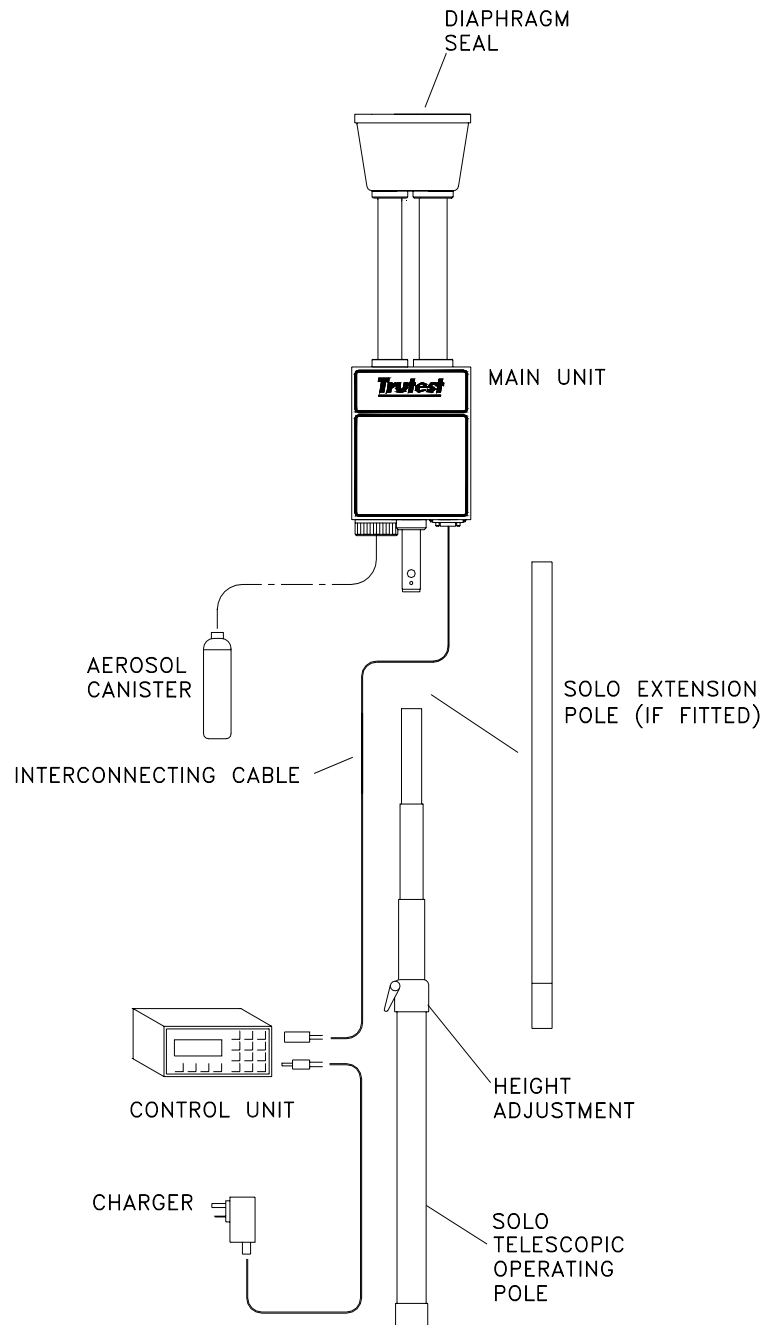

Fig. 1

3.2. COMPONENTS OF TRUTEST

3.2.1 The Control Unit

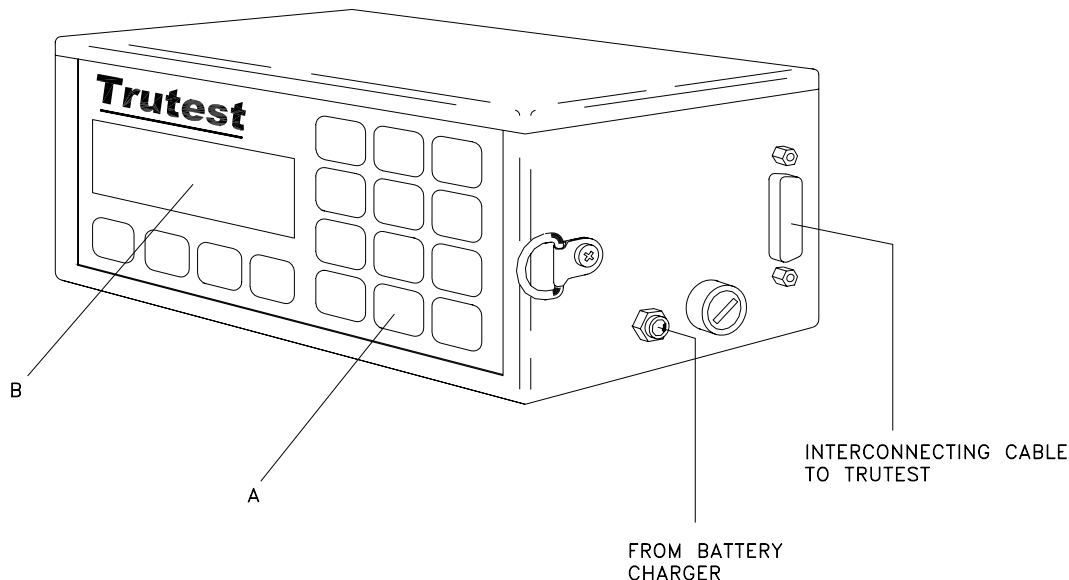

Fig. 2

Carried on a shoulder strap by the operator, the control unit incorporates a microprocessor, LCD display, keyboard and rechargeable battery pack. Commonly used test limits may be pre-stored within the microprocessor for instant recall when required (see Section 4.5., Entering New Test Parameters for Max/Min Mode). At each stage in the test sequence the control unit displays to the user what is happening through visual displays and audible prompts. The control unit is connected to the main unit via the interconnecting cable.

Components of the Control Unit:

3.2.1.1 The keyboard (A): A membrane keypad incorporating tactile contacts that have a soft click action to provide confirmation of operation.

3.2.1.2 The display (B): A 20 character x 4 line LCD display module utilizing supertwist nematic technology to provide a high contrast, wide viewing angle display.

3.2.1.3 The microprocessor within the control unit controls the operation of the whole system. It provides a user interface via the keypad and LCD display and controls the aerosol generation, circulation and sensing within the main unit.

3.2.1.4 **The rechargeable battery pack** within the control unit will provide sufficient power for a day of testing. It may then be recharged overnight via the battery charger provided.

Note: *The control unit features an auto power down. If left on, it will automatically switch off after fifteen minutes, thereby saving battery power.*

3.2.1.5 **The sounder** within the control unit produces the following sounds to prompt the user at different stages in the test sequence:

- a) When a key is pressed - half second beep.
- b) During initialization stage - a single beep every five seconds.
- c) During smoke test stage - a slow double beep every five seconds.
- d) If an error occurs - a single two-second continuous beep to draw the attention of the user to the display (see section 6.4.).
- e) During max/min testing - a rapid double beep at the min value, and a rapid triple beep at the max value (see section 4.3.1.).
- f) During clearing stage – a rapid double beep when the 50% clear level is reached and Trutest should be removed from the detector under test (see section 4.8.3.).

3.2.1.6 **Calibration** is factory adjusted and set. Data for the calibration is stored in the control unit during manufacture. Between annual services, there is no need for any interim adjustments, since Trutest is self calibrating.

IMPORTANT: Since the control unit maintains the calibration of the main unit, and should never be interchanged with any other control unit. The serial numbers on the main and control units should always match.

3.2.2. The Main Unit

The main unit is a lightweight assembly that is lifted to cover the detector. It comprises the aerosol dispenser, central aerosol reservoirs, sensor tube, transparent detector cup and return tube. Similar to a smoke tunnel, the test aerosol produced from the canister is taken up the sensor tube where it is measured, before passing through the transparent detector cup covering the detector under test and returning down the return tube for recirculation. The aerosol concentration is continually monitored by the microprocessor via the sensor. The transparent detector cup enables the LED alarm indicator of the detector to be seen illuminating on successful activation of the alarm.

Note: *The main unit contains no user-serviceable parts. The operator needs only to replace aerosol cans from time to time. The unit should not be opened by the user and any action in this respect other than by an authorized service center will invalidate all warranties and guarantees.*

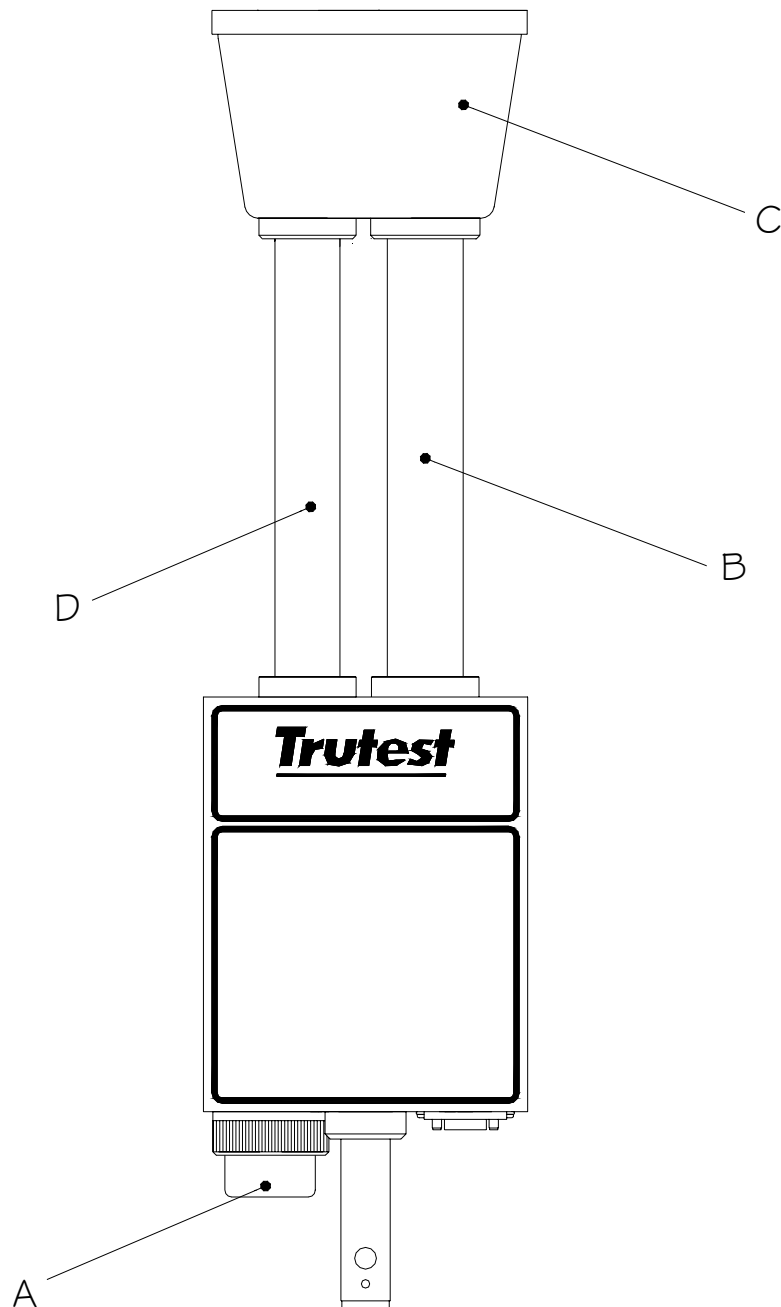

Fig. 3

Components of the Main Unit:

- 3.2.2.1 The Aerosol Canister (A).** The aerosol canister contains an "environment friendly", pressurized gas formulation which produces the test aerosol cloud. The aerosol particle sizes simulate the spectrum of particles generated by the smoke of a real fire.

 **CAUTION**

AEROSOL CANISTERS CAN BE HAZARDOUS. Pressurized containers can explode if correct method of storage and use is not observed. Contents can be ignited under certain conditions.

When using/handling/storing the Trutest aerosol:

- Always follow the instructions on the canister. Failure to do so will increase the risk of injury.
- Read the Safety Data Sheet supplied with the product.
- **CONTENTS UNDER PRESSURE.** Protect from direct sunlight and do not expose to temperatures exceeding 120°F (50°C). Do not pierce or burn, even after use.
- Use in a well ventilated area. Avoid deliberate inhalation / Do not breathe spray.
- Avoid skin and eye contact.
- **KEEP OUT OF THE REACH OF CHILDREN.**
- The Trutest aerosol is not defined as flammable by §1500.3 (c)(6), 16CFR, Federal Hazardous Substances Act, C.P.S.C. Regulations, USA. **HOWEVER, THE PRODUCT CAN BE IGNITED UNDER CERTAIN CIRCUMSTANCES. DO NOT SPRAY ON A NAKED FLAME OR ANY INCANDESCENT MATERIAL.**
- Keep away from sources of ignition – No smoking.
- 20% by mass of the contents are flammable.

The number of detectors that can be tested with one aerosol canister will depend on the type of test and state of the detector under test. Typically one aerosol canister may be expected to perform over one hundred tests. Once fitted into its retaining cylinder, the aerosol dispenser is activated by a solenoid within the main unit.

Note: *Only aerosol cans specifically marked for use within Trutest can be used within this device. The use of any other aerosols will invalidate results and may cause irreparable damage to Trutest. Always re-order the same aerosol part number.*

3.2.2.2 The Solenoid. Under the control of the microprocessor the solenoid mechanism operates the pressurized aerosol canister **(A)** to release short bursts of aerosol into the aerosol reservoir. This dense aerosol cloud is slowly fed, by a controlled fan, into the sensing loop comprising the sensing chamber, sensor tube **(B)**, detector cup **(C)** and return tube **(D)**.

The aerosol density in the sensing loop has a much lower concentration than in the reservoir, and it is this aerosol cloud which is circulated up the sensor tube, past the smoke detector under test, and back down the return tube. The fans within the sensing loop and the design of the loop tube are arranged so that the airspeed over the smoke detector is maintained at approximately 0.6ft/s or 1.3ft/s for ionization and photoelectric detectors respectively - the optimum airspeed specified to operate smoke detectors.

3.2.2.3 The Sensor measures the aerosol concentration in the sensor tube before it enters the detector cup. Trutest uses a very stable and accurate light obscuration sensor. The sensor is fully self-monitoring and self-calibrating in the event of any contamination on the optical surfaces. The output derived from it corresponds to the prescribed method for sensitivity measurement specified for photoelectric smoke detectors in the UL268 standard for point type smoke detectors. An internal correlation to ionization detectors (within Trutest) has been established and verified to enable accurate sensitivity readings to be made of both ionization and photoelectric detectors.

3.2.2.4 The Detector Cup (C) is transparent, enabling the user to see the LED of the detector when it activates. The detector is sealed within the cup by a diaphragm seal. A red stripe is provided on one side of the cup that may be aligned with a feature of the detector, such as its LED, to indicate the detector's orientation in the cup. It is recommended that future or repeat tests on the same detector are performed in the same orientation in order to minimize directional dependence i.e. the variation in reading due to detector orientation relative to the direction of airflow in the cup.

3.2.2.5 Diaphragm Seals: Two interchangeable silicone diaphragm seals are supplied with the basic kit. Each one is color coded for a particular range of detector sizes (see section 8.1., Trutest

Specifications). Before testing a detector, the user should always check that the correct size seal is being used in order that a good seal is maintained around the detector. The diaphragm helps to seal the detector within the cup, reducing leaks, and together with the slight positive pressure within the sensing loop, preventing the ingress of clean air into the sensing loop after the aerosol concentration has been measured by the sensor.

3.2.3. Telescopic Operating Pole

The SOLO Telescopic Operating Pole supports Trutest while in use, by means of four telescopic sections. The upper two sections will lock at full extension only, but the lower section will lock at any position using the height adjustment clamp. Trutest mounts on the top of the pole directly and the pole is erected to the desired height using the top two sections of pole first, engaging the spring buttons fully. If there is insufficient room to erect any section, then move to the third section and erect it to the desired height before clamping gently with the height adjustment clamp.

The Trutest main unit is located over the detector, and the telescopic poles rest on the floor for the entire duration of the test. The SOLO telescopic pole permits tests on detectors within the range 6ft 5" to 16ft 10" from the floor. For detectors at greater heights, a SOLO extension pole can be used (see below).

If the detector is mounted at an angle (i.e. not horizontally), it may be simpler to exchange it with one that is mounted horizontally in an accessible position. The sensitivity tests can then be carried out on it using Trutest, before returning it to its original position. Be sure to carry out a further **functional** test on both detectors which have been moved (as distinct from the **sensitivity** test just completed by Trutest) once they have been restored to their final positions. The SOLO range of tools are usually available from your Trutest supplier and permit simple removal and functional testing of detectors.

3.2.4. Extension Poles (optional)

A SOLO extension pole can be added to the SOLO telescopic pole to reach to greater heights. This is added between the SOLO telescopic pole and Trutest. A maximum working height of up to 20ft 8" can be obtained by using a single extension pole.

Detectors mounted at greater heights that require testing should be interchanged with those mounted lower. (Contact the supplier of this system for additional information on removal and replacement tools).

 **WARNING**

Trutest is used above head height.

- **Read the Safety Instructions at the start of this User Manual. Failure to do so will increase the risk of injury.**
- **When using Trutest at height, extreme care should be taken. The unit must be carefully controlled when mounted on poles above head height. At great heights this requires some skill.**

3.2.5. Battery Charger

A 12V NiCd battery is incorporated within the control unit. When fully charged it will enable the operator to complete more than one day of continuous testing. The total number of tests obtainable from one charge depends on the type of test that Trutest is asked to perform and the sensitivity level and type of detector under test. Battery Chargers for North America, Japan, Europe, Australia and the UK are available, and a charger for your country should be included in the kit.

To charge the battery, connect the charger to the outlet and to the control unit charger socket (see Fig.2). Charging takes 14-16 hours if the battery is completely exhausted. Do not leave the charger connected indefinitely. Overnight charging is recommended prior to using Trutest. The charger and the Trutest base unit may become slightly warm during charging. This is quite normal.

3.2.6. Interconnecting Cable

Connects the main unit of Trutest to the control unit. Two lengths of cable are supplied, 2.5m and 5m, to suit operation at different heights. The user should use the most convenient length in each application.

3.2.7. Aerosol Canisters

Depending on the type of test and the sensitivity level of the detector under test, a single aerosol canister should perform over one hundred tests. Canisters are usually supplied in quantities of twelve cans.

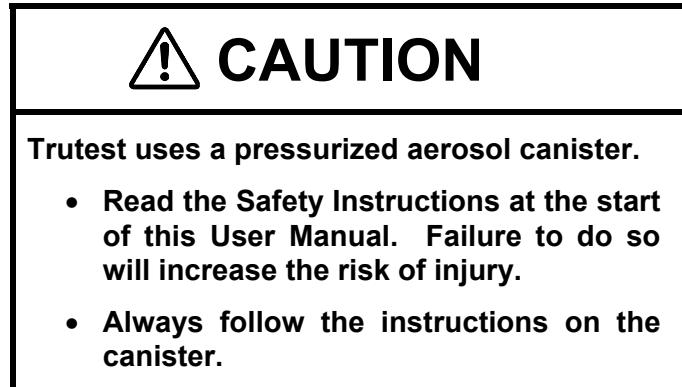

3.2.8. Carry / Store Case

Trutest (excepting SOLO telescopic and extension poles) is packed in a custom case with carrying handle and shoulder strap. Each component has its own compartment. All components should be stored neatly in the case when not in use.

3.2.9. Pole Bag (optional)

A separate pole bag is available for the SOLO telescopic operating pole and extension pole. This is designed to attach neatly and securely to the Trutest carry case such that all equipment is easily transported together.

3.3. SELECTING AND FITTING THE DIAPHRAGM SEALS

Two interchangeable silicone diaphragm seals are supplied with the basic kit. These fit to the top of the transparent detector cup and are used to seal the detector under test within the cup. The seals each cover a different range of detector sizes and are color coded for easy reference.

The pink diaphragm is suitable for testing detectors of diameter from 2.8 to 4.3 inches. The gray diaphragm is suitable for testing detectors of diameters 3.7 to 5.7 inches. Select and fit the required diaphragm for the detectors to be tested.

3.4. FITTING THE AEROSOL CANISTER

The aerosol canister is inserted into the main unit from the base of the main unit as follows:

- a) Locate the main unit at a convenient working height, not above the head.
- b) Ensure the locking ring "A" is in the released position by turning it anticlockwise (see Fig. 5)
- c) Remove empty canister (if present) from main unit.
- d) Shake the new canister well before use.
- e) Insert new canister such that the nozzle points towards the center of the main unit. If the nozzle is pointing in any other direction, the canister will not fit correctly, and Trutest will not work. Rotate the canister as you insert it so that you can feel the nozzle locate correctly.
- f) Pressing can **firmly** up into position, tighten the locking ring "A" securely by turning it in a clockwise direction.

Note: Only aerosol canisters marked for use in Trutest should be used. These are specifically designed for use with Trutest. Any other aerosol is likely to produce incorrect results, and may possibly damage either Trutest or the detector or both. The Trutest aerosols are environmental friendly with a non-flammable propellant gas and are strictly controlled in quality and aerosol characteristics.

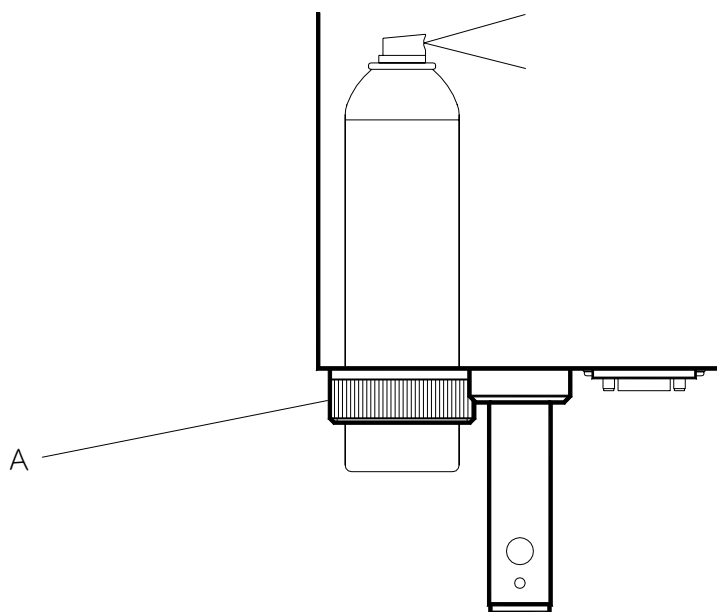

Fig. 5

3.5. PREPARATORY CHECKS

Before assembling Trutest for use, check the following:

- a) Ensure that the battery in the unit is fully charged.
- b) Ensure that you have the correct poles and extensions required to access the height of the detector.
- c) For detectors fitted at heights greater than normal ceiling height, ensure that you have suitable removal tools to enable removal of detectors at height if the detector fails the test and needs replacing. Such tools are usually available from the supplier of Trutest.
- d) Ensure that all safety precautions are taken, including additional precautions for working at height. See the Safety Instructions at the start of this manual.
- e) Ensure that you have a sufficiently full can of aerosol before starting any testing. Check that you have a full spare can too.
- f) Ensure that the serial number on the main unit is the same as on the control unit. Trutest calibrates the main unit and control units together, and they should not be interchanged.

3.6. ASSEMBLING THE EQUIPMENT

- a) Determine the type and model of detector to be tested and select the correct diaphragm seal for that detector from the size specifications. Fit this securely to the top of the transparent plastic cup of the main unit.
- b) Fit aerosol canister as described above, ensuring that the nozzle of the aerosol has been inserted correctly into the main unit and is pointing toward the center of Trutest.

 **WARNING**

- **Always ensure that the Trutest aerosol canister is firmly located and secured in Trutest, before raising the unit above head height.**

This will mean that the canister will not be displaced during operation.

- c) Attach the interconnecting cable between Trutest main unit and control unit of appropriate length for the height you will be working.
- d) Fit Trutest to the top of the SOLO telescopic operating pole, or to the top of an extension pole, should greater height than approx. 17ft. be required.

Rotate the top section of the SOLO telescopic pole or the extension pole when Trutest is positioned on top, to lock the spring button.

- e) Next, if an extension pole is used, fit the base of the extension pole to the top of the SOLO telescopic operating pole. Always assemble with the poles in an upright position, adding the extension to the bottom of Trutest, and then adding the telescopic pole beneath the extension pole, rather than by assembling the entire length on the floor and lifting. Lifting the unit from the horizontal may lead to the poles becoming damaged. Check that the extension pole, if fitted, is latched properly to the SOLO telescopic operating pole (by rotating the extension until the button engages) before extending the latter as detailed below.

 **WARNING**

- Do not use Trutest unless it is **securely** mounted in the correct manner on the specified operating poles.
- Always ensure that the spring buttons on the operating poles and the stem at the base of Trutest's main unit are fully engaged, before raising the unit above head height.

Failure to observe these instructions can result in Trutest falling from the working height.

- f) Place yourself and the Trutest unit directly below the detector to be tested and raise the unit towards the detector. Starting with the top (smallest diameter) pole of the SOLO Telescopic Operating Pole, extend each section to its maximum height and latch the spring buttons by rotating the pole until the button engages.
- g) When you reach the stage when the next section will not extend fully, use the lowest telescopic section to finally raise the unit until Trutest's clear cup is positioned over the detector, ensuring that the inlet vents of the detector are well sealed within the cup by the diaphragm seal. Gently tighten the height adjustment clamp to retain this position, with the base of the SOLO Telescopic Operating Pole resting on the ground.
- h) The whole assembly should support its own weight, but the user should ensure that it is stable at all times. **Never leave the poles and Trutest unattended**, even for short periods.

This page is intentionally blank

4. OPERATING INSTRUCTIONS

4.1. PREPARING TO TEST

- a) Check that the unit has been correctly assembled as described in the assembly instructions (Chapter 3) before turning on the power. In particular, ensure that the battery has been charged, and the aerosol canister has been correctly installed (see section 3.4., Fitting the Aerosol Canister).

 WARNING
<ul style="list-style-type: none">• Always ensure that the Trutest aerosol canister is firmly located and secured in Trutest, before raising the unit above head height. <p>This will mean that the canister will not be displaced during operation.</p>

- b) Press the "On/Off" key. The title screen will be displayed as below.



- c) This is followed automatically by one of the default screens (those which have "Press Start to test" at the bottom of the screen). For example:

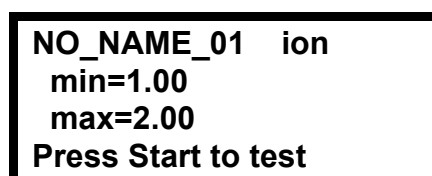

or

**Fast ramp
photo
hi profile
Press Start to test**

or

**Slow ramp
ion
hi profile
Press Start to test**

d) The user must determine which type and model of detector is to be tested, and which type of test is to be performed. The control unit requires up to three pieces of information to be set prior to performing the test.

- i) Detector type - photoelectric or ionization and high or low profile.
- ii) Test mode - fast ramp, slow ramp or max/min mode.
- iii) The setup number (if testing in max/min mode).

This information is entered into the control unit by means of the keypad. The current settings are displayed on the screen.

4.2. SELECTING THE DETECTOR TYPE

Trutest has a different smoke and air flow characteristic to that of the UL smoke box. Conversion factors are used to achieve good correlation between Trutest and the UL smoke box. These conversion factors are different for photoelectric, ionization and the height profile of the detector. Therefore, **the user must select the correct detector type** before beginning each test.

Use the "Det. type" key on the keypad to sequence through the detector types displayed on the screen. The four options are:

- photo lo profile for low profile photoelectric detectors
- photo hi profile for high profile photoelectric detectors
- ion lo profile for low profile ionization detectors
- ion hi profile for high profile ionization detectors

Detectors that protrude more than one third into the cup should be considered as high profile.

4.3. SELECTING THE TEST MODE

Use the "Test mode" key on the keypad to toggle between these three types of test:

1. Max/min (see section 4.3.1.)
2. Fast ramp (see section 4.3.2.)
3. Slow ramp (see section 4.3.3.)

4.3.1. Max/Min Test

This is used to carry out a quantitative check. Trutest tests whether the sensitivity of the detector falls within an acceptance band or range of sensitivities. It does this by ramping up the concentration of aerosol in the sensing loop, notifying the user when certain pre-determined levels of sensitivity are reached. These parameters are entered by the user against the name of the detector according to its sensitivity rating (see section 4.5., Entering New Test Parameters for Max/Min Mode). To choose which detector setup to use for a max/min test, see Section 4.4., Selecting a Detector Setup for Max/Min Mode.

The user stops the test when the detector alarms, as usual, and Trutest reports either a 'Pass', a 'Fail Over-sensitive' or 'Fail Under-sensitive' result (see section 5.3., Results Screen for Max/Min Test). This result is determined by whether the alarm occurred before, after, or in between the expected minimum and maximum sensitivity values for the detector.

During the test, when the obscuration in the sensing loop reaches the level of the minimum sensitivity parameter entered, a rapid double beep is heard, and a small indicator arrow appears on the display adjacent to the minimum value. Similarly, when the obscuration reaches the level of the maximum sensitivity parameter, a rapid triple beep is heard and the arrow moves to the maximum value. It is simple and quick to tell whether the detector has alarmed within its stated sensitivity band.

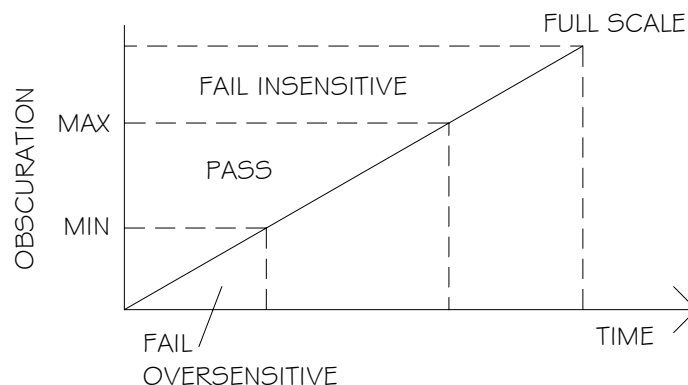

Max. is the maximum reading of obscuration in %/ft required to activate the detector. This figure can be determined from the higher sensitivity rating of the detector (printed on the label on the base of most UL listed detectors or from the manufacturers' data sheets) plus any uncertainties in the measurement. For example, Trutest measurement uncertainty (see section 8.1., Trutest Specifications). Detectors which fail to alarm at, or before, this level are deemed to be under-sensitive.

Min. is the minimum reading of obscuration at, or below, which the detector should not activate. This figure can be determined from the lower sensitivity rating of the detector (printed on the label on the base of most UL listed detectors or from the manufacturers' data sheets) minus any uncertainties in the measurement. For example, Trutest measurement uncertainty (see section 8.1., Trutest Specifications). Detectors that activate at, or prior, to this level are deemed to be over-sensitive.

Detector name is a ten character alphanumeric, user selectable label.

4.3.2. Fast Ramp Test

This is used to carry out a fast quantitative check. Trutest increases the concentration of aerosol in the measuring cup and records the point at which the detector alarms. This figure may then be compared with the minimum and maximum acceptable levels specified by the detector manufacturer on the detector or in their data sheets.

The fast ramp test should not be used on detectors with built in delays, as the concentration of aerosol in the sensing loop at the time the detector alarms, may be significantly higher than the level at which the detector was actually triggered, before the delay. This can produce misleading results. In general, the slow ramp mode gives more accurate results, but can take much longer to test a detector than the fast ramp mode.

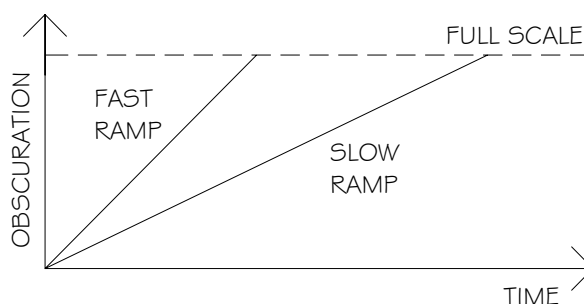

4.3.3. Slow Ramp Test

This is the most accurate measurement of sensitivity within Trutest, and is used to carry out normal quantitative measurements.

Because of delays built into certain detectors the ramp rate needs to be fairly slow to give an accurate reading. If the ramp rate is too fast, a delay in the detector could mean that the reading of obscuration will have risen considerably since the detector alarm threshold was reached, but before the detector alarmed visibly. This will lead to a higher %/ft reading being recorded.

4.4. SELECTING A DETECTOR SETUP FOR MAX/MIN MODE

The control unit can store up to eighteen sets of max/min test parameters for the min/max testing of the user's most commonly tested detectors. These can be recalled instantly from within the microprocessor's memory when required. Each set of test parameters, numbered 1-18, consists of data concerning the detector, including the maximum and minimum sensitivity acceptance limits stored for that detector.

Before running a max/min test, a make/model of detector needs to be selected from one of the 18 detector setups stored in memory. (If the required detector has not been entered previously it can be entered into the memory by the user, see section 4.5., Entering New Test Parameters for Max/Min Mode.) The user selects the required detector setup as follows:

- a) Using the "Test mode" key on the keypad , select max/min testing.
- b) If the required detector is not already displayed, press the "Set-up" key on the keypad. (Step (a) may be omitted if the user wishes to enter setup directly from the default screen). The following menu will be displayed:

1.Recall Setup
2.Change Setup
3.Number of Tests

- c) Select option 1 by pressing the numeric key "1". A screen similar to the following will appear:



01: NO_NAME_01 photo

Which one 01-18?

The display shows a detector setup that has been entered previously. The example above shows setup number 1. The cursor will be positioned under the top left-hand character ("0" in example screen shown above).

- d) To choose a different detector setup, press the appropriate numeric keys. Even if the number is below 10, two key presses must be entered. For example, for detector setup number 5, enter "0", then "5".

When a number is entered, the display will immediately show any detector setup stored under that number. If an alternative is required, simply type in another number. Press "Enter" to confirm the selection. The display will show the max/min parameters for the detector selected. This allows you to check that these are the correct settings for the detector, prior to beginning the test:

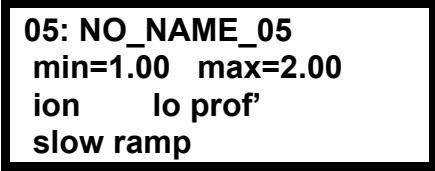

05: NO_NAME_05
min=1.00 max=2.00
ion lo prof'
slow ramp

- e) Press the "Enter" key again to accept the detector selection.

4.5. ENTERING NEW TEST PARAMETERS FOR MAX/MIN MODE

The user can enter up to eighteen sets of max/min test parameters for their most commonly tested detectors.

Each set of test parameters, numbered 1-18, consists of the maximum and minimum sensitivity limits for each detector, the type of detector (ionization or photoelectric), the profile of the detector (high or low profile), and the speed of the ramp (slow or fast) during max/min test. The user programs these parameters in the following manner:

- a) From any of the default screens, (see Section 4.1., Preparing to Test) press the 'Set-up' key on the keypad. The following menu screen will appear:

**1.Recall Setup
2.Change Setup
3.Number of Tests**

- b) Select option 2 by pressing the number "2" on the keypad. The following screen will appear:

**01: NO_NAME_01 photo

Which one 01-18?**

- c) The display shows a detector setup that has been entered previously. The example above shows setup number 1. The cursor will be positioned under the top left-hand character ("0" in example screen shown above).
- d) To choose a different detector setup, press the appropriate numeric keys. Even if the number is below 10, two key presses must be entered. For example, for detector setup number 6, enter "0", then "6".

When a number is entered, the display will immediately show any detector name/description already stored under that number. If an alternative is required, simply type in another number. Press "Enter" to confirm that you wish to enter/modify the parameters of this selection. The display will show the max/min parameters for the detector selected, with a cursor, "→", to prepare for entry or modification:

**06: →NO_NAME_06
min=1.00 max=2.00
ion lo prof'
slow ramp exit**

- e) Position the cursor at the field(s) that needs to have new data entered. The cursor is moved about the screen using the keypad 'arrow' keys: "2", "4", "6", and "8" representing "down", "left", "right"

and “up” respectively. Press “Enter” to modify or enter data in that field.

- f) With the cursor positioned adjacent to the detector name field, pressing the “Enter” key reveals the following screen:

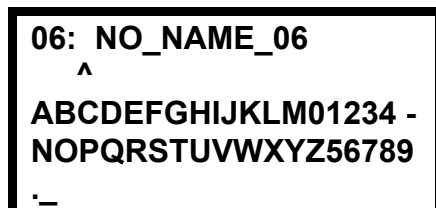

```
06: NO_NAME_06
  ^
ABCDEFGHIJKLM01234 -
NOPQRSTUVWXYZ56789
  -
```

A new cursor, “^”, shows beneath the first character of the detector name. New characters can be used in this name/description by changing each one in turn.

- g) To change the character with the “^” cursor beneath it, move the flashing block cursor (using the ‘arrow’ keys as above) to the desired character in the list shown in the lower half of the screen. To accept the currently shown choice of character, press “Enter”.

After the final character has been accepted, the user is returned to the setup screen to continue with other parameter entry.

- h) For the “min” or “max” fields, simply enter the new values from the keypad. If a value outside the full-scale capability of Trutest is entered, and the “exit” option from the setup screen is chosen, a continuous warning beep of five seconds will sound, and the cursor will be returned to the offending value for alteration. For details of the full-scale values, see section 8.1., Technical Specifications.
- i) For the detector type field (ionization or photoelectric), the “Enter” key toggles between “ion” and “photo”. Since the full-scale obscuration values for photoelectric and ionization tests are different, a value for the “max” field which is acceptable for tests on photoelectric detectors, may not be acceptable should the detector type be later changed to ionization. In this case, when the “exit” option from the setup screen is chosen, a continuous warning beep of five seconds will sound, and the cursor will be returned to the offending value for alteration. For details of the full-scale values, see section 8.1., Technical Specifications.
- j) For the detector profile field (high or low profile), the “Enter” key toggles between “hi prof” and “lo prof”.
-

- k) For the ramp speed field (slow ramp or fast ramp), the “Enter” key toggles between “slow ramp” and “fast ramp”.
- l) When all parameters have been entered/modified as required, move the cursor to the “exit” field and press “Enter”. Trutest saves all the changes and returns to the screen, which was displayed prior to entering setup. If Trutest is turned off prior to this, any modifications or changes to the parameters will not be saved.

4.6. STARTING THE TEST SEQUENCE

After the operator has assembled the system (see section 3), set the detector type and the test mode (see section 4), the test can begin.

4.6.1 Locate the clear cup of the main unit around the detector to be tested with the diaphragm sealing around the top of the detector. **It is important that a good seal be obtained between the diaphragm and the detector.** The response threshold of the detector may vary slightly depending on its orientation relative to the direction of airflow in the cup. The red stripe on the side of the cup can be aligned with a feature of the detector, such as its LED, to indicate the detector’s position in the cup for future or repeat tests. By always testing the detector in the same orientation, variations of reading due to directional dependence can be minimized.

4.6.2 Use the telescopic poles to rest the unit on the floor. Press the "Start" key on the control unit keypad to initiate the test sequence. Trutest automatically establishes a circulation of clean air within the sensing loop to initialize and zero the internal sensor. This is the initialization stage, during which the display will read "**Resetting Sensor**" and an intermittent beep will be heard from the control unit every five seconds. The display shows a countdown starting at 7, and lasting about thirty seconds.

For example, the display reads (for slow ramp, fast ramp and min/max tests respectively):

<p>Slow ramp ion hi profile Resetting sensor 7</p>
--

or

**Fast ramp
photo
hi profile
Resetting sensor 7**

or

**NO_NAME_01 ion
min=1.00
max=2.00
Resetting sensor 7**

This 'initialization stage' can be carried out without the Trutest cup positioned over the detector e.g. when moving from one test to another, but must be in place for the test to begin (see below).

4.6.3 On completion of the initialization stage the smoke sensitivity test will automatically commence. The selected type of test will be conducted (either slow ramp, fast ramp or max/min). Trutest maintains a constant airspeed past the detector while a carefully controlled smoke density is gradually increased. The user will hear the solenoid mechanism pulse the aerosol canister, along with a double beep from the control unit every five seconds. The smoke obscuration reading as measured by the internal sensor is displayed on the screen. Some example screens are shown below, for slow ramp, fast ramp and min/max tests respectively:

**Slow ramp
ion
hi profile
Reading=0.98 %/ft**

or

**Fast ramp
photo
hi profile
Reading=1.80 %/ft**

or

NO_NAME_01 ion
min=1.00
max=2.00
Reading=0.62 %/ft

4.6.4 At this point the user is simply a witness as Trutest performs the test. He/she should watch the detector to ensure that the diaphragm is sealed around the top and wait for the LED of the detector to activate when the detector reaches its alarm level. The audible intermittent beep from the control unit assures the user that a test is in operation.

4.7. THE END OF THE TEST

4.7.1 When the detector activates, and the detector Alarm LED lights, press the "Stop" key on the control unit keypad to finish the test. The user will then be presented with the appropriate result screen (see section 5.6., Interpretation of Results).

4.7.2 The test sequence will stop automatically if the detector has not activated (i.e. the "Stop" key has not been pressed) by the time the equipment reaches the full-scale obscuration limit (see section 8.1., Technical Specifications). The result screen should then be checked for the exact reason for the end of the test (see section 5.5., Interpretation of Results).

4.7.3 In all cases, once the test has completed, Trutest unit will rapidly establish a circulation of clean air within the sensing loop to clear the detector and the Trutest Unit (see section 4.8.2).

4.8. COMPLETING THE TEST AND CLEARING THE SMOKE

4.8.1 The result from the screen; either a pass or fail (in the case of a max/min test), or a smoke sensitivity reading (in the case of a ramp test or a max/min test), should now be recorded. The results will remain displayed until the "Enter" key on the keypad is pressed. (A typical results page is printed in Appendix B at the back of this manual).

4.8.2 At the end of the test Trutest rapidly starts to clear the smoke from the detector and its own internal airways and sensor. The amount cleared is

shown on the result screen. When the "Enter" key is pressed, the display returns to the default screen, still showing the amount of smoke cleared from the internal sensing loop. For example (max/min screen):

NO_NAME_01 ion
min=1.00
max=2.00
Clearing smoke 80%

4.8.3 The clearing cycle has two stages:

Stage 1 - Detector clearing (0 - 49%)

It is recommended that the user keeps the detector within the plastic cup during this stage. This will clear any aerosol from the smoke detector so that it will not re-alarm when the fire alarm system is reset. Note however, that there will be very little aerosol to clear since the test will have been stopped as soon as the detector has activated (i.e. at the absolute minimum concentration required to activate an alarm).

Stage 2 - Removal of Trutest (50 - 100%)

When Trutest has reached 50% clear the user will be prompted to "Remove Trutest" and a rapid double beep is heard. It is advisable to withdraw the unit from the detector at this time, as that will help to clear the smoke from the sensing loop more rapidly.

NOTE: Leaving Trutest in position over the detector during this stage will increase the clearing time.

Do not switch off Trutest until all of the smoke clearing stages have completed. The smoke clearing cycle will last between thirty seconds and 3 minutes depending on the concentration of aerosol to clear.

4.8.4 The test is now complete. If another detector is to be tested, the user can go immediately to it and start the next test. However, do not cover the new detector until the smoke clearing stage is complete, and the display shows: "Press Start to test" (see section 7.1. Questions on Usage for a tip on speeding up testing).

If no further testing is required, use the "On/Off" key on the keypad to switch off the control unit and conserve power.

5. RESULTS

5.1. GENERAL OBJECTIVE OF RESULTS

Trutest has been designed to perform on-site sensitivity tests on all makes of smoke detector. The sensitivity of a detector may be defined as the density (concentration) of smoke required to trigger an alarm. Testing with Trutest should enable the user to identify:

- a) The ability of the detector to respond to the presence of a pre-defined external smoke stimulus. Much time can be saved since the detector does not need to be removed from its base, tested, replaced and then re-tested for function within the system.
- b) The ability of the installed detector to communicate with the panel and raise an alarm.
- c) Those detectors which may be outside acceptable sensitivity limits. These can then be cleaned or replaced.
- d) Any drift in sensitivity of conventional detectors (similar to the function of analogue detectors but with Trutest a true external stimulus is used) and to take corrective action.

5.2. RESULTS SCREEN FOR RAMP TEST

5.2.1 At the point that the "Stop" key is pressed and the test stopped, the final level of obscuration is displayed. This figure may then be compared with the minimum and maximum acceptable levels specified by the detector manufacturer, or may be noted for future comparisons.

5.2.2 The obscuration figure is in %/ft, corresponding to the minimum level of smoke required to activate the detector.

Result:

**Reading=1.85 %/ft
Press Enter**

- 5.2.3** If the obscuration level reaches the maximum level attainable (see section 8., Technical Specifications) and the detector has not alarmed, the test will stop automatically and the message “Full scale” will replace the “Result” field on the screen. For example, the following screen shows a ramp test which reached a maximum attainable obscuration value of 6.00%/ft:

Result:

Full scale=6.00 %/ft

Press Enter

If the Trutest main unit or the aerosol canister is below its standard operating temperature range (i.e. below 50°F (10°C)), the unit may not be able to reach the normal full-scale range. This can also be caused by a faulty aerosol nozzle. However, the display will still report a full-scale reading at the point at which it stopped, even though this may be below the normal maximum. The reading displayed will be the maximum obscuration obtained during the test.

5.3. RESULTS SCREEN FOR MAX/MIN TEST

With the max/min test, Trutest provides a pass or fail result, depending on whether the detector alarmed within or outside the pre-programmed acceptance band. The actual sensitivity reading is shown, and the final result is also displayed as a pass or fail. In some cases, there can be an indeterminate outcome from the max/min test, and this will be displayed also.

- 5.3.1** If the detector LED is seen to illuminate (the detector activates) before the “min” value is reached, and the key is pressed to stop the test, the results display will read (for an alarm level of 0.6%/ft in this example):

Result:

Failed oversensitive

Reading=0.60 %/ft

Press Enter

- 5.3.2** If the detector LED is seen to illuminate (the detector activates) between the “min” level and the “max” level, and the key is pushed to stop the test, the results display will read (for an alarm level of 2.3%/ft in this example):

Result:
Detector passed
Reading=2.30 %/ft
Press Enter

- 5.3.3** If the detector LED does not illuminate (the detector does not activate) by the “max” level, and the key is pushed to stop the test, the results display will read (for an alarm level of 3.1%/ft in this example):

Result:
Failed insensitive
Reading=3.10 %/ft
Press Enter

- 5.3.4** If the detector LED does not illuminate (the detector does not activate) and the maximum attainable obscuration level is reached (full scale) prior to the “max” level in the max/min test, the test will stop automatically. Since it is not known whether the detector would have alarmed at a higher level, but still below the “max” level, an indeterminate result is displayed. For example, the following screen shows a max/min test which reached a maximum attainable obscuration value of 5.35%/ft, but the “max” value entered for the detector was 5.50%/ft:

Result:
Indeterminate Result
Full scale=5.35 %/ft
Press Enter

See section 5.2.3 for details of the “Full scale” condition when this occurs at a level below the maximum values specified in section 8.

5.4. WARNINGS SHOWN ON RESULT SCREENS

Any of three warning messages may be communicated to the user on the result screens. In place of the first line, and in addition to the results and other parameters on the result screens, there may be one of the following warning messages, which the user must heed (shown in order of priority):

- a) Service due soon!
- b) Battery voltage low!
- c) Sensor drifted!

Each of these messages is described in Section 6.4., Warning Messages.

Should more than one of these messages be relevant at the time of a result screen display, only the highest priority warning will be shown.

A two-second warning beep will accompany any of these warning messages to alert the user.

A typical result screen with a warning message may look like this (example shows a max/min result screen with a pass result):

```
Service due soon!  
Detector passed  
Reading=2.30 %/ft  
Press Enter
```

5.5. STORED RESULTS

The unit will store results of the last two tests until the power is turned off.

- a) If the user requires reference to a previous test result press the left arrow key ("4"). The following is an example of a result screen which would be displayed (this example shows a ramp test result):

```
Result:  
  
Reading=1.85 %/ft  
Press Enter
```

- b) If the result of the second last test is required, press the left arrow key ("4") again. The following is an example of a result screen which would be displayed (this example shows a passed max/min test result):

```
Previous Result:  
Detector passed  
Reading=2.61 %/ft  
Press Enter
```

Pressing the left arrow key ("4") repeatedly will toggle back and forth between the two result screens shown in (a) and (b) above.

5.6. INTERPRETATION OF RESULTS

IMPORTANT - READ CAREFULLY

It should be noted when using Trutest, that there are a large number of factors affecting the sensitivity readings, which should only be judged within the conditions and limits quoted in the Technical Specifications. Detector sensitivity readings can change depending on the orientation of the detector, environmental conditions, wind conditions, differences between Trutest units and aerosol canisters, and the repeatability of the detector.

These systematic and random uncertainties which relate to Trutest are generally covered within the figures quoted in the Technical Specifications. Note also that repeated tests on the same detector, can result in inaccurate readings, if the test aerosol is not given sufficient time to clear totally from the detector. Depending on the detector concerned, this could take as long as five minutes, although in practice, the clearing cycle will stop after about two to three minutes.

All sensitivity results displayed should generally be compared with those values provided by the manufacturer as acceptable for that detector in the field, but also taking into account any uncertainties in the measurement. The manufacturer's values should be printed on the base of the detector, or in the data sheets. Trutest measurement uncertainties are shown in section 8.1., Trutest Specifications. Should any results fall outside of the acceptance parameters, the detector may be considered to be over or under sensitive.

It should be noted that figures from one manufacturer of detectors should not be compared with figures from another manufacturer in an effort to determine superiority of one detector over another. Any conclusions drawn in this manner would be at best subjective and misleading.

Where specific results are not available for a particular model of detector, the user may take a sample number of readings from similar detectors installed on their site, and by statistical means, establish a nominal acceptance band. This is described in more depth in Appendix C. Further, by recording the results of "Ramp Tests" over time on a given detector it is possible to track any drift of that detector.

5.7. ACTION IF A DETECTOR FAILS A TEST WITH TRUTEST

If a detector fails a sensitivity test, there are steps you should take prior to condemning it.

1. Ensure that the aerosol canister in Trutest is not nearly empty. This can easily be determined by shaking the canister and listening for any remaining liquid. If it is nearly empty, replace it with a new canister before proceeding.
2. Ensure that there has been a good seal between the detector and the silicon membrane during the test.
3. Ensure that you have entered the correct details of the detector into Trutest e.g. ionization/ photoelectric and lo/hi profile.
4. The detector should be retested. Be sure to allow adequate smoke clearing time between tests.
5. Also be sure to allow for all measurement uncertainties in your sensitivity acceptance thresholds before condemning detectors. See section 8.1. Trutest Specifications for details of the measurement uncertainties in Trutest. Other uncertainties may exist within the system also e.g. delayed alarm response of detectors, which will be more apparent on fast ramp readings.

Should the detector fail on retest, taking all the above into account, then the detector can be assumed to be out of tolerance.

The detector should now be replaced with another one of the same type and model, and the replacement one should be tested. Note that some detector manufacturers allow for cleaning of their detectors, in which case the faulty detector should be cleaned on site, or returned for cleaning. Please refer to the respective manufacturer for information on cleaning or replacing detectors. If a detector is returned for servicing, it is recommended to mark the final Trutest reading on the detector, including the calculated uncertainty in the measurement.

6. SERVICE AND MAINTENANCE

Trutest is a high quality electronic test instrument and as such, regular calibration and servicing as well as care in use are essential. Regular calibration ensures reliability, and continuing accuracy in use. It is recommended that this product be returned to an authorized service center annually. After 5,000 tests the unit will automatically shut down until it has been serviced.

6.1. USER SERVICING

Little user servicing should be necessary and the user should not attempt to service this equipment beyond that described in this manual. All other servicing should be referred to qualified service personnel at authorized service centers.

6.1.1. Cleaning

From time to time you should wipe the equipment with a soft cloth. For heavier dirt, dampen a soft cloth in a weak solution of mild detergent and water, wring it dry, and wipe off the dirt. Following this, dry immediately with a clean cloth. Do not use rough materials, thinners, alcohol or other chemical solvents or cloths since these could damage the finish or remove the equipment labels. Only qualified service personnel should perform cleaning of the internal parts.

6.1.2. Damage Requiring Servicing

This equipment should be serviced (by qualified service personnel) when:

- a) Objects have fallen or liquid has been spilled into the equipment.
- b) The equipment has been exposed to rain.
- c) The equipment does not appear to operate normally or exhibits a marked change in performance.
- d) The equipment has been dropped or the enclosures damaged.

6.1.3. Replacing the Fuse

The fuse holder is located on the side of the control unit and is clearly labeled. Never replace the fuse with any other type / rating than that recommended in the specifications. To replace the fuse, use a flat bladed screwdriver to undo the screw cap, replace the fuse with an identical replacement and refit. If the fuse repeatedly blows, return the ENTIRE Trutest kit for servicing.

6.1.4. User Calibration Check

Trutest has been factory calibrated and tested. There is no reason to believe that there will be any shift in calibration or accuracy, since the sensor is self-monitoring and self-adjusting. If the sensor is damaged the unit will shut down and will not perform tests. However if the user wishes to be sure of the calibration of the unit over an ongoing period, the following is recommended:

- a) Take two detectors of factory quality: one ionization and one photoelectric.
- b) Test these detectors with Trutest and record the results. Use all modes of test.
- c) Keep the detectors in a safe, dry, dust-free environment.
- d) After a period of using Trutest, test the detectors again, recording the results. Should the difference be greater than the expected Trutest repeatability PLUS the repeatability of the detector, then it may be necessary to have Trutest re-calibrated.

Note: *No attempt should be made to open Trutest. Entry and subsequent servicing is permitted only by an authorized service center.*

6.1.5. Membrane Condition Check

The condition of the membranes used to seal the Trutest cup to the detector should be checked periodically. Should there be any damage to these membrane seals, results could be affected. Replacements should be obtained from your Trutest supplier in this case.

6.2. ANNUAL SERVICING

In order to maintain the accuracy and performance from this instrument, it is recommended that Trutest be returned to an authorized service center for an annual service and re-calibration. This should be performed annually or after 5,000 tests, whichever is the sooner.

However, Trutest monitors the number of tests performed and announces to the user when calibration is due. Once the test limit of 5,000 tests has been exceeded Trutest will not permit further use without re-calibration and will need to be returned to an authorized service center. A charge will be made for this service.

The number of tests performed, and how many remain before obligatory service, can be determined by referring to the Service Screen on the control unit. The product may also have to be returned to a Service Center if other problems occur (see section 6.4., Warning Messages and section 6.5., Troubleshooting Guide). Overseas customers should confirm with the supplier when purchasing where the closest authorized service center is located.

6.3. SERVICE SCREEN

The user can determine the number of tests Trutest has performed since the last service via the Service Screen as follows:

- a) From any of the default screens, (see section 4.1., Preparing to Test) press the 'Set-up' key on the keypad. The following menu screen will appear:

1.Recall Setup
2.Change Setup
3.Number of Tests

- b) Select option 3 by pressing the numeric key "3". The number of tests performed and the number of tests remaining before service are displayed on the service screen as follows:

Tests=4000
To service=1000

Press Enter

- c) Press 'Enter' to return to the original default screen.

6.4. WARNING MESSAGES

The following warning messages are generally preceded by a two-second continuous beep from the control unit.

6.4.1. Low Battery

- 6.4.1.1** When the NiCd Battery is drained almost completely, the Low Battery Warning message is displayed. If the condition arises during a test, the message will appear on the result screen, but will not interfere with the test. For example:

Battery voltage low!

Reading=1.05 %/ft

Press Enter

At this time, Trutest is able to complete approximately 12 more tests, or one hour of testing. It should then be recharged before further use.

- 6.4.1.2** When the battery is completely drained, (after approximately 12 more tests or one hour of testing), a further battery warning will appear during the initialization stage:

Warning!

Battery voltage low!

Press Enter

After this warning, the display will return to the start screen, but will not allow any further tests to be performed.

6.4.2. Service Warnings

Trutest automatically monitors the number of tests it has performed in order to provide warning when calibration is imminent. Trutest will permit 5,000 tests before automatic shut down.

- 6.4.2.1** A warning message will occur when the number of tests remaining before service goes below 250. The message appears on the result screen, for example:

**Service due soon!
Detector passed
Reading=1.97 %/ft
Press Enter**

The user can determine exactly how far away he/she is from an obligatory service by interrogating the control unit (see section 6.3., Service Screen).

- 6.4.2.2** When the 5,000 test limit is finally reached Trutest will automatically shut down when the "Start" key is pressed and will not permit any further tests. Instead, the following message will be displayed:

**Warning!
Service due NOW!

Press Enter**

6.4.3. Empty Aerosol Can

If the aerosol concentration starts to drop rapidly during a test, the aerosol canister probably needs replacing, and the following message will be displayed:

**Warning!
Can empty!

Press Enter**

At this stage, a new aerosol canister should be fitted, and the test restarted (see section 3.4., Fitting the Aerosol Canister).

6.4.4. Sensor Drift

If the following message appears on a result screen:

**Sensor drifted!
Detector passed
Reading=2.64 %/ft
Press Enter**

this means that the sensor may be dirty, blocked or misaligned. The results may be unreliable and care should be taken with their interpretation. The unit should be returned to an authorized service center for servicing and re-calibration.

6.4.5. Wiring Fault

If the following screen appears:

**Warning!
Head not fitted!

Press Enter**

the user should check whether the main unit is correctly connected to the control unit. When everything has been checked, press the "Enter" key and try the test again. This could indicate a fault with the interconnecting lead, so try the other lead if the message persists. After this, if the warning continues, it could indicate a fault with the sensor. In this case, contact a service center.

6.4.6. System Error

If the following screen appears:

System error 0x

the user should press "on/off" on the control unit to reset the system. If it re-appears the user should check the wiring and connections. If it persists, the unit should be returned for service.

6.4.7 Min/Max Error

Should the setup parameters for a min/max test be entered in such a manner that the full-scale obscuration value of Trutest is exceeded for that type of detector, Trutest alerts the user prior to saving setup information. New data entry is prompted, thus ensuring that parameters are within the normal operating range of Trutest.

6.5. TROUBLESHOOTING GUIDE

The following problems do not require professional servicing. If the problem cannot be remedied using this guide, contact your authorized service center for assistance.

Problem	Possible Causes	Remedy
<i>Blank screen, no response from on/off key.</i>	Blown fuse.	Check and replace.
	Flat Battery.	Recharge.
<i>"Head not fitted" warning.</i>	Interconnecting cable not fitted properly.	Check connections at both ends of cable.
<i>No response from main unit</i>	Interconnecting cable not fitted properly.	Check connections at both ends of cable.
<i>Detectors do not alarm.</i>	Faulty detectors.	Check against known detector.
	Wrong settings.	Check settings for correct "Det. type", "Test mode" and "Setup".
<i>Problems obtaining high obscuration Levels.</i>	The system has a leak.	Ensure detector is sealed within cup by diaphragm. Check main unit for visible leaks. If found, return the unit to an authorized service center.
		Check condition of diaphragms and replace if damaged or broken.
	Aerosol or room temperature too low.	Check temperature is above 50°F on gauge on main unit. Warm aerosol canister slightly in heated office or car for 30 minutes. (Do not place on radiator or fire).
<i>No rise in obscuration reading on display.</i>	No aerosol canister in main unit.	Check and fit.
	Empty aerosol canister.	Check and replace.
	Dented aerosol canister.	Check and replace.
	Aerosol canister incorrectly loaded.	Check against instructions in manual.
<i>Unstable reading during ramps or poor control.</i>	Wrong main unit parameters stored in the control unit.	Check that the serial numbers on the control unit and main unit match.

7. FREQUENTLY ASKED QUESTIONS

7.1. QUESTIONS ON USAGE

Q: Does Trutest suit all makes of smoke detector?

A: Yes, Trutest has been developed specifically to this end. It is used normally to test against the maximum and minimum values printed on the base of the detector, or in the manufacturers' data sheets. However, where manufacturers' figures are unavailable, a site can still be tested, and individual detectors compared to the average values obtained for that site. A method to produce these field values, is described in section C.1. of the Appendices.

Q: Is Trutest applicable to 'self testing' analogue systems?

A: Analogue addressable and intelligent sensors can only monitor the 'clean air response' or normal quiescent response of the internal sensor. This however does not test the actual alarm level, nor can it take into account variations in atmospheric conditions (dust, air movement, etc.). To determine the response of the sensors to smoke, they still need to be tested periodically with a controlled and measured source of test aerosol. By testing with Trutest can you be sure of the sensitivity to smoke and the continuing accuracy of the sensor.

Q: How long does a test take?

A: The total time required for a sensitivity test varies according to the type of test, the type of detector, and the sensitivity of the detector. Trutest works by gradually increasing the smoke density presented to the detector, therefore the more sensitive the detector, the quicker it will respond. Generally however, a test will take between three and five minutes, including the sensor initialization stage, and the final smoke clearing. In addition, the time taken to get to the next detector, and to position the Trutest unit should be added to give an overall idea of time.

A slower test will generally be a more accurate one since there are often delays in the alarm circuitry of detectors and panels (see section 4.3.3).

TIP: *The smoke clearing stage generally takes between thirty seconds and three minutes, and works faster if the main unit is removed from the detector when indicated on the display. The operator can go on to the next detector, and prepare Trutest for the next test, while waiting for the smoke clearing stage to finish. Even the next initialization can be started whilst 'on the move' between tests, provided that Trutest is located over the detector in time for the test to start.*

7.2. QUESTIONS ON SENSITIVITY & CALIBRATION

Q: How do I know that Trutest will give accurate results?

A: Trutest has been tested at Underwriters Laboratories in the United States, where it has been given a generic listing as an accessory for automatic fire detection systems. The readings on Trutest's LCD are correlated directly to the UL smoke box. Note that readings should always be interpreted correctly in the light of the specification of Trutest and the detector under test. See section 5.6., Interpretation of Results for more details.

Q: Is Trutest's UL listing good for all makes of detector?

A: Trutest has a generic UL listing, which means that it is listed to work with any make of detector.

Q: How will I know that Trutest is correctly calibrated at the start of a test?

A: Trutest is fully self-adjusting and re-calibrates itself at the start of a test. It therefore automatically takes account of any contamination within the system and adjusts to compensate for it. If this is a concern the user can perform his own tests with a detector of known quality at given intervals to prove this. (See section 6.1.4. User Calibration Check).

Q: What is the time interval between services?

A: As Trutest is a high precision test tool, periodic workshop verification and re-calibration will be necessary. To meet international quality standards, a service is required at least once per year, or every 5,000 tests, whichever occurs earlier. The sensor is programmed to "auto shut down" after 5,000 tests or if a problem is detected, and will give a warning before that. See Section 6.2 Annual Servicing.

Q: What happens when the sensor is unable to self-calibrate?

A: Trutest will no longer give results and the LCD will display a message to this effect (indicating a fault with the sensor). At this point the unit will need to be returned for service.

Q: Can the user make adjustments?

A: The only user adjustments are made from the front panel e.g. for detector setup parameters and test selections. There are no user adjustments within the main unit or the control unit.

7.3. QUESTIONS ON EFFECTS OF TEMPERATURE & HUMIDITY

Q: What is the effect of temperature on performance:

A: Extensive tests have been carried out to determine the effect of temperature on the performance of Trutest. As Trutest uses a liquefied gas aerosol canister, the critical operating temperatures are determined by the gas characteristics. The maximum operating temperature is limited to 95°F, as the maximum storage temperature for the aerosol canister is 120°F in line with international safety requirements.

The lower temperatures are, however, far more critical for the performance of the Trutest. If the aerosol canister temperature is too low, the internal pressure drops rapidly and produces too many large particles. This is normally seen when Trutest cannot reach the maximum obscuration level shown in the specifications, but shows a full-scale reading at a lower level. The specified minimum operating temperature of 50°F, is very critical. At this temperature, the performance starts to rapidly drop off, and could affect the detector readings. Always check the room temperature as shown on the indicator strip on the side of the main unit, and ensure that the aerosol canister is at, or above, this temperature when testing.

Note that the action of spraying the aerosol canister causes internal cooling. Therefore the more testing is performed, the lower the temperature drops in the main unit and aerosol canister.

TIP: *Keep a spare Trutest aerosol canister in a warm (i.e. room temperature) place (e.g. in an office). When the temperature in the aerosol canister drops below 50°F (10°C), exchange it with the warm canister. Also allow a slightly longer time than usual for recovery between tests. This will allow the main unit to recover to the ambient room temperature.*

Q: What effect does relative humidity have?

A: The particles of aerosol smoke used within Trutest, as with all smoke particles, are affected by very high levels of relative humidity. At high levels of humidity, where the air is saturated with water, the smoke or aerosol particles act as nuclei for small droplets of water to form. These are not seen as easily by the smoke detectors, and can give a false sensitivity reading. Additionally, as the release of the high-pressure contents from the aerosol canister has a cooling effect, the relative humidity level is reduced further, so that water particles start to form.

TIP: *Relative humidity tends to be highest at sunset and sunrise in some climates (this causes dew). If the sensitivity readings for a number of detectors appear to be suspect in the early morning or late evening, it could be caused by high humidity. Try retesting these detectors in the middle of the day.*

7.4. QUESTIONS ON TRUTEST AEROSOL

Q: How consistent and repeatable are the aerosol characteristics?

A: Very. This is a function of the aerosol canister, chemical formulation, valve and spray nozzle. All are subject to strict quality control (as is the rest of Trutest).

Q: What effect does "aging of smoke" produce?

A: With ionization smoke detectors there are often concerns due to 'aging' of smoke. Tests were carried out in which a high concentration of aerosol was maintained up to 120 seconds. The results showed that this process did not affect the relative sensitivity of ionization detectors.

Q: How many tests can the user get from a canister of aerosol?

A: This will depend on the type of test that Trutest is asked to perform, the design of the detector and the relative state of sensitivity of the detector under test. An average of 100 tests per canister can be expected.

Q: What is in the aerosol canister?

A: The Trutest aerosol uses a mixture of an "environmentally friendly", non-flammable propellant gas liquefied at high pressure with non-toxic active ingredients. It has been tested for compatibility with detectors and users. For more details see the aerosol health and safety data sheet supplied with the product. Note that being a pressurized container, it will need sensible handling and be subject to certain transport regulations. Always follow the instructions on the canister.

Q: Can the Trutest aerosol smoke be ignited?

A: The Trutest aerosol is not classed as flammable by the Federal Hazardous Substances Act, which determines the correct level of classification and labeling for aerosol goods in the USA. However, since almost anything can burn if sufficient energy is deployed, it is possible to ignite the spray under very severe conditions. These conditions have been investigated and have been confirmed by UL not to exist either in Trutest nor in its operating environment. As an analogy of this situation, consider a housebrick, which although it burns under certain conditions, is virtually impossible to ignite with a match.

Q: Can any other smoke aerosol canister be used in the device?

A: No. The tool is designed to use only the special Trutest aerosol canisters, and a different product would not work or give correct results. Other formulations could cause serious damage to both the detector under test and Trutest.

Q: Why do ionization detectors require a greater concentration of aerosol to activate?

A: The particle size distribution of the aerosol, has a relatively higher concentration of larger particles recognized by photoelectric detectors than ionization detectors. This is a deliberate design feature, as the internal obscuration sensor is more sensitive to the larger particles enabling more consistent measurements for both types of smoke detectors.

7.5. QUESTIONS ON BATTERIES AND POWER

Q: How long will one charge of the batteries last?

A: This depends on many factors; different types of test consume different amounts of power. In normal use the batteries last for 8-10 hours of continuous testing. If the tester is switched off whilst moving from detector to detector, this will give at least one full day of testing. The control unit display will prompt visibly and audibly if the batteries are low and it can be recharged overnight. In general, for each hour of charging, the unit will manage one hour of testing.

Q: What would happen if the machine were accidentally left switched on?

A: The machine incorporates an automatic shut down after fifteen minutes without use.

7.6. QUESTIONS ON USER INPUT / USER INTERFACE

Q: How do I set the make and type of detector for each type of test?

A: No specific detector set-up is required for ramp mode, although you do need to select the detector type (ionization, photoelectric, high or low profile). Set-up data for the max/min mode is input via a menu prompt system. The required information is detailed in section 4.4 of this manual "Selecting a Detector Setup for Max/Min Mode"

Q: How does the user know what stage of the test cycle is running?

A: Either by looking at the message on the display or by hearing different beeps from the control unit.

Q: What memory has Trutest?

A: The microprocessor has an internal memory for storing detector settings. Some of this memory is the non-volatile EEPROM type, which will retain information even with the power, is removed. It is used to:

- store default settings;
- store user programmed settings;
- record information relevant to servicing.

7.7. QUESTIONS ON RESULTS AND DISPLAYS

Q: Can the results be recorded?

A: Only by hand. After a test has been completed the results are displayed on the LCD until the "Enter" key is pushed. They can be transferred manually to the results page that is found at the back of the manual. The last two results are stored in volatile memory and can be displayed by toggling the left arrow ("4") key.

7.8. QUESTIONS ON WEIGHT, INSULATION AND PRACTICAL USAGE

Q: What about the weight?

A: Some parts of Trutest are relatively heavy. However, the control unit is suspended on a shoulder strap and the SOLO Telescopic Operating Pole permits the unit to be rested on the floor during testing. This means that the weight of the main unit is never borne for long.

Q: Is the unit electrically insulated (to save the operator from any shock from live cables that may contact the device)?

A: The SOLO Telescopic Operating Pole is made from insulating composite materials to protect the user when accidentally touching high voltage supplies. However the unit should not be viewed as being completely non-conductive. Extreme care should be taken when working near any electrical installations or overhead power lines.

Q: How do we cope with detectors fitted in situations where Trutest can not reach or fit?

A: The detectors which cannot be accessed can either be removed from their bases and placed in more accessible bases (exchanging the detectors) or powered up separately and tested.

Q Can Trutest be used on detectors mounted on sloping ceilings or which have to be accessed from an angle?

A: To a very limited degree. If the aerosol canister is tipped too much, it may not dispense the correct particle sizes. It may be better to exchange with detectors in more accessible positions. You should always ensure that the diaphragm seal properly seals the detector within the cup.

Q: Will Trutest cope with deeper detectors (e.g.: older style or those sitting on junction boxes)?

A: Yes, so long as a seal can be achieved with the diaphragm. Note that only the sensing chamber of the detector has to be sealed within the cup.

This page is intentionally blank

8. TECHNICAL SPECIFICATIONS

8.1. TRUTEST SPECIFICATIONS

Part No.	Component	Dimensions	Weight
SOLO100	Telescopic Operating Pole		3lb 15oz (1.80kg)
	Length (extended)	14ft 9ins (4.50m)	
	Length (not extended)	4ft 2ins (1.26m)	
SOLO101	Extension Pole	44ins (1.13m)	12oz (0.35kg)
TRUT710	Extension Cable	8ft 2ins (2.50m)	7oz (0.19kg)
TRUT711	Extension Cable	16ft 4ins (5.00m)	11oz (0.32kg)
TRUT730	Height Adjustment Clamp		2oz (0.06kg)
TRUT300	Main Unit (excluding aerosol)	8 x 4 x 29ins (195 x 105 x 740mm)	5lb 13oz (2.65kg)
TRUT351	Control Unit	7 x 3.5 x 4.5ins (175 x 85 x 110mm)	3lb 8oz (1.6 kg)
TRUT753 + TRUT781/ 2/3/4/5	Battery Charger (complete with regional adapter)	3.5 x 2 x 1.3ins (90 x 50 x 35mm)	6oz (0.16 kg)
TRUT702	Gray Diaphragm Seal	Detectors dia. 3.7 - 5.7ins	2oz (0.06kg)
TRUT703	Pink Diaphragm Seal	Detectors dia. 2.8 - 4.3ins	2oz (0.06kg)
TRUT600	Trutest Carry Case	33.5 x 13.5 x 8.5ins (850 x 345 x 210mm)	4lb 11oz (2.12kg)
SOLO602	Carry bag for SOLO poles	50.0 x dia.4.0ins	13oz (0.38kg)
TRUT771	User Manual (this document)		4oz (0.12kg)
TRUT760	Spare Fuse Pack (3 per pack)		0.5oz (0.01kg)
AERO400	Aerosol Canister	2.1ins dia. x 6.8ins (52mm dia. x 177mm)	11oz (0.31 kg)

OPERATING DATA

Trutest uncertainties in sensitivity measurements: *(Note: For correct interpretation of results, the tolerance of the detector under test and any other measurement uncertainties must also be taken into account). Specified at 68°F +/- 5°F < 60% RH , using slow ramp.*

All detector types and profiles \pm (10% of reading + 0.6 %/ft)
typically \pm (10% of reading + 0.3 %/ft)

Operating Parameters:

Maximum Working Height:	20ft 8ins (6.3m) (using SOLO100 + SOLO101)
Average Test Time:	120 seconds
Average Calibration Time:	40 seconds
Average Clearing Time:	120 seconds
Average Tests per Aerosol Canister:	100 tests
Average Battery Life:	8-10 hours testing on a full charge
Test Stream flow rate:	0.6ft/s to 1.3ft/s (0.2 to 0.4m/sec)
Resolution:	0.01 %/ft
Aerosol Concentration Range	
Maximum for ionization:	4.00 %/ft
Maximum for photoelectric:	6.00 %/ft
Rate of Rise of Aerosol Concentration	
Slow Ramp:	0.50 %/ft / minute
Fast Ramp:	1.00 %/ft / minute

Type of Aerosol

See Section 8.2 and Safety Data Sheet

Environment:

Operating Temperature:	50°F to 95°F (+10°C to +35° C)
Storage Temperature:	15°F to 120°F (-10°C to +50° C) <i>(Do not store in direct sunlight)</i>
Humidity:	0 - 85% RH non-condensing

Fuses

Fuse Rating	1A Anti Surge
Fuse Style	20 mm Glass Tube

Battery

Nominal Voltage:	12VDC
Capacity:	2.5Ah
Charger Nominal Voltage:	18VDC

8.2. AEROSOL DATA

Description:

Part Number: AERO400
General Description: An environmentally friendly aerosol canister for use with Trutest Smoke Detector Sensitivity Tester.

Specifications:

Dimensions: 2.1ins (53mm) dia x 6.8ins (173mm)
Pressure: 18 bar maximum
Material: Aluminum monobloc
Contents: 9.5oz (270g)
approx. 8.5fl oz (250ml)
Operating Temperature: 50°F to 95°F (+10°C to +35° C)
Storage Temperature: 15°F to 120°F (-10°C to +50° C)
Aerosol: Blended Oxy-hydrocarbons
Propellant: 1,1,1,2 Tetrafluoroethane

Physical Data:

Boiling Point: -15.7°F (-26.5°C)
Vapor Pressure: 95lb/in² (6.70kg/cm²) at 77°F (25°C)
Liquid Density: 75lb/ft³ (1.20kg/dm³) at 77°F (25°C)
Appearance: Colorless gas, liquid under pressure
Odor: Very faint ethereal odor

Occupational Exposure Limit:

Gas: 1000ppm (3540mg/m³) (Long term exposure limit – 8 hr TWA reference period)
General: Very low acute toxicity; weak anaesthetic at very high concentrations. Not mutagenic in Ames test or CHO cell assay.

See No Climb Products Health and Safety Data Sheet MDS 0065 for more details.

Fire / Hazard Class:

Not defined as flammable by §1500.3 (c)(6), 16CFR, Federal Hazardous Substances Act, C.P.S.C. Regulations, USA. HOWEVER, THE PRODUCT CAN BE IGNITED UNDER CERTAIN CIRCUMSTANCES. 20% by mass of the contents are flammable.

DoT Registration:

DOT2Q, registration no. M5215

UL Listing: 77TL Smoke-Automatic Fire
Detector Accessory. Generic listing.

Environmental Information: Tetrafluoroethane is not currently regulated under the Montreal Protocol and may be used as a replacement for regulated CFC's.

 **CAUTION**

AEROSOL CANISTERS CAN BE HAZARDOUS. Pressurized containers can explode if correct method of storage and use is not observed. Contents can be ignited under certain conditions.

When using/handling/storing the Trutest aerosol:

- Always follow the instructions on the canister. Failure to do so will increase the risk of injury.
 - Read the Safety Data Sheet supplied with the product.
 - CONTENTS UNDER PRESSURE. Protect from direct sunlight and do not expose to temperatures exceeding 120°F (50°C). Do not pierce or burn, even after use.
 - Use in a well ventilated area. Avoid deliberate inhalation / Do not breathe spray.
 - Avoid skin and eye contact.
 - KEEP OUT OF THE REACH OF CHILDREN.
 - The Trutest aerosol is not defined as flammable by §1500.3 (c)(6), 16CFR, Federal Hazardous Substances Act, C.P.S.C. Regulations, USA. HOWEVER, THE PRODUCT CAN BE IGNITED UNDER CERTAIN CIRCUMSTANCES. DO NOT SPRAY ON A NAKED FLAME OR ANY INCANDESCENT MATERIAL.
 - Keep away from sources of ignition – No smoking.
 - 20% by mass of the contents are flammable.
-

Note: *In summer or on hot days extra care should be taken to protect from sunlight and other high temperatures. Even the boot of a car can reach excessive temperatures. If in doubt, an insulator / "Thermos" type bag should be used to store cans.*

APPENDIX A - AUTHORIZED SERVICE CENTERS

A.1 UNITED KINGDOM

No Climb Products Limited
Edison House
163 Dixon's Hill Road
Welham Green
Hertfordshire
AL9 7JE
UK

Telephone: +44 (0)1707 282760
Facsimile: +44 (0)1707 282777
Email: sales@detectortesters.com
Website: www.detectortesters.com

A.2 UNITED STATES OF AMERICA

SDi
3535 Route 66, Building 6
Neptune, NJ 07753 USA

Telephone: (732) 751 9266
Facsimile: (732) 751 9241
Email: sales@sdifire.com
Website: www.sdifire.com

APPENDIX B - RESULTS PAGE

Serial Number of Trutest Used _____ Date of Tests _____ Sheet _____ of _____
 Name of Test Engineer _____ Name of Client _____ Location (Site, Town, City, Country) _____

Detector Tested	Location	Type of Test	Result	Comments / observations
<i>Model, Type</i>	<i>Within site</i>	<i>Fast / Slow Ramp or Max/Min</i>		<i>State of detector / Site conditions</i>

Notes: _____

APPENDIX C. - DETECTOR PERFORMANCE TABLES

C.1. Method for Producing Detector Performance Tables

If you cannot find the details for the particular type and model of detector you wish to test, the following procedure should be followed:

1. Test a representative sample of the same model and type (e.g. 6) on slow ramp.
2. Test all the detectors on the site (or on more than one site if you have 20 or less of each type), and record the results.
3. At this stage, you should already be able to spot the detectors which are obviously out of norm, as they will be considerably different from the average (up to two times higher, or 2/3 less than the average values).
4. Add up all the values for each model of detector, and divide by the number of detectors to give an average or *Mean* value for that model.
5. To generate *Minimum* and *Maximum* values, a ratio between *Min* and *Max* should be agreed. A typical figure for this could be 1:2.2. To create a ratio of 1:2.2 of *Min* to *Max*, use the following formula:

$$\begin{aligned} \text{Min} &= \text{Mean} \times 0.625 \\ \text{Max} &= \text{Mean} \times 1.375 \end{aligned}$$

6. The *Minimum* and *Maximum* values can be used to check the results already recorded, and can be programmed into Trutest as explained in section 4.5 of the manual. The values chosen should be recorded on a blank Detector Performance Sheet (see Appendix C.2.).

C.2 Detector Performance Sheet

Site: _____

Date: _____

¹ Model <i>Manufacturer Ref. No.</i>	System Type <i>Conventional / Addressable</i>	Detector Type <i>Photoelectric / Ionization</i>	² Max.	³ Min.	⁴ Diaphragm <i>Pink or Gray</i>

- ¹ Model The manufacturer's reference or model number for this detector.
- ² Max. The maximum sensitivity level for this detector model. The detector should have activated by this stage when tested with Trutest.
- ³ Min The minimum sensitivity level for this detector model. At this obscuration value, the detector should not activate when tested with Trutest.
- ⁴ Diaphragm The size of diaphragm seal to be used to seal this particular detector.